

PRODUCT SHEET

Description:

Central Lock 851N/500mm, $\varnothing 19 \times 22$ mm, NPL, CK SISO, 8mm Pegs W/Screws

Item number:

14.01.327-5

Units	Box	Carton	HS Code	Barcode
Pcs.	24	120	8301300000	
				5704866501446

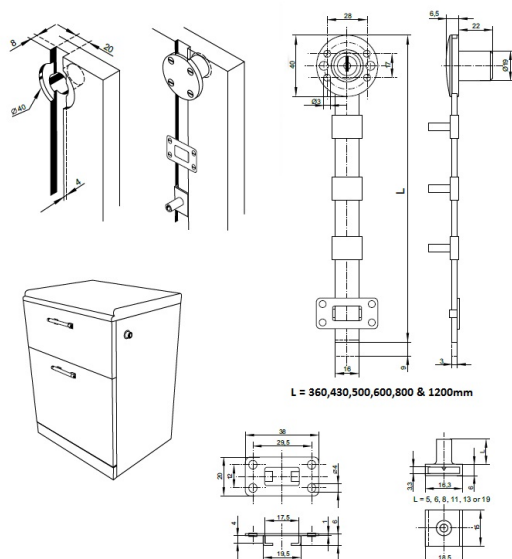

SISO A/S

Mileparken 11
DK-2740 Skovlunde
Denmark
VAT: DK 24786013

Phone +45 45 830 900

www.siso.dk
siso@siso.dk

Danske Bank
Nytorv Branch
Copenhagen
SWIFT: DABADKKK

Account no.
4180 3112 112936
IBAN Account
DK7230003112112936